

Device Manual

Chapter 3.1-W sensonic II



G.83.0128 - Release 8.2.0 CH 2014
ista International GmbH - Grugaplatz 2 - 45131 Essen
<http://www.ista.com>

1	Device data	3
1.1	General information	3
1.2	Functional description	4
1.3	Device display	5
1.4	Technical data	8
1.5	Approval	10
1.6	Main and connection dimensions	11
2	Item numbers	12
3	Installation notices	18
4	Installation	19
4.1	Mounting meter	19
4.2	Installation of the temperature sensor in the immersion sleeve /" (Ø 5 mm)	20
4.3	Install temperature sensor in the ball valve and single-pipe connector (SPC) with slot for temperature sensor	21
4.4	Final steps	21
5	Commissioning	22
6	Exchange	23
7	Disposal	24

i

1 Device data

1.1 General information

Device group Compact heat meter

Product name sensonic II

Pictogram

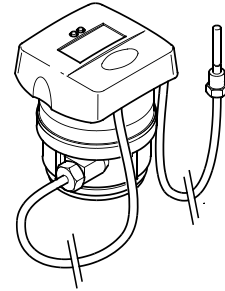
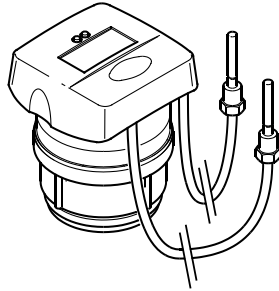

Options / add-ons With the help of the optosonic 3 radio net the heat meter sensonic II can be integrated into the ista radio net system symphonic sensor net.

- Variants
- sensonic II
 - q_p 0,6 / 1,5 / 2,5
 - all q_p variants optionally symmetric oder asymmetric
 - all q_p variants also as cold meter
 - all q_p variants also as combined heat / cold meter (hybrid)
 - sensonic II mbus
 - q_p 0,6 / 1,5 / 2,5
 - all q_p variants optionally symmetric oder asymmetric
 - all q_p variants also as cold meter
 - all q_p variants also as combined heat / cold meter (hybrid)

- Components
- Flow sensor
 - Microprocessor calculator
 - Temperature sensors for flow and return

Packaging Single package (1 pc. per carton)

1.2 Functional description

To determine the heat quantity, it is necessary to measure the status parameters volume, flow and back-flow temperature.

The volume component of the sensonic II is a multi-jet flowmeter. The volume impulse generation takes place in line with the principle of inductive scanning. The measurement configuration comprises an oscillating circuit with a coil in the dry part of the meter and a triangular damping plate on the impeller.

1. Damping plate
2. Encapsulated coil
3. Impeller

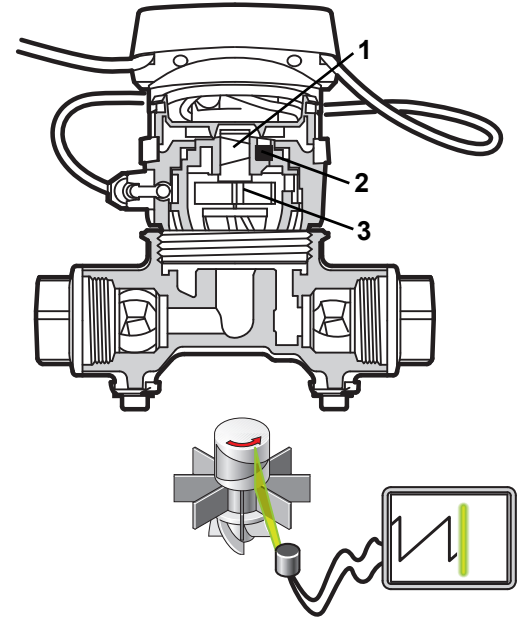

Depending on the positioning of the impeller, the oscillating circuit registers different attenuations, which are converted into output impulses proportional to volume by the evaluating electronic unit.

The flow direction is calculated using the shape of the resulting attenuation curve.

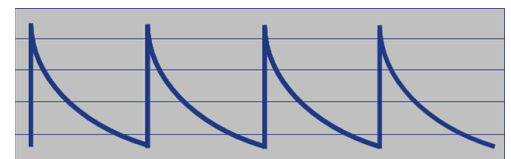
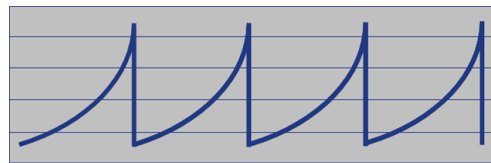

The measurement of the flow- and backflow temperature is controlled with a platinum resistance thermometer.

Since volume, density and the stored heat quantity of water vary depending on the temperature, it is necessary to correctly calculate the amount of heat by arranging a density- and an enthalpy correction (enthalpy: latin for heat content). For this, the calculator calculates a common correction factor.

From the measured temperature and volume, as well as the calculated correction factor, the microprocessor calculator of the sensonic II determines the currently consumed heat quantity by using the following formula:

$$Q = V \cdot (t_V - t_R) \cdot K$$

(heat quantity = volume · (flow - backflow temperature) · correction factor)

1.3 Device display

Display

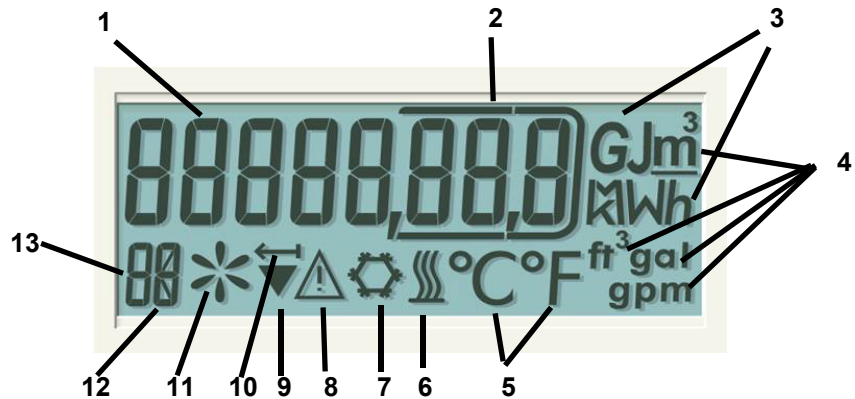

1. Numeric display
2. Frame, marks decimal places
3. Dimensional units for energy (kWh, MWh, GJ)
4. Dimensional units for flow rate (m³, ft³, gal, gpm)
5. Dimensional units for temperature (°C, °F)
6. Symbol for heat metering
7. Symbol for cold metering
8. Symbol for error
9. Symbol for individualised resolution
10. Symbol for wrong flow direction
11. Symbol for flow available
12. Letter of the display
13. Number of the display loop

Display loops

Switching between displays:

- horizontal: automatic
- vertical: by pressing the key

Switching between display loops: extended key actuation



NOTICE

- ▶ In all loops, the only readouts to be displayed are those that are required for the respective device variants (heat, cold or combined heat/cold meters).

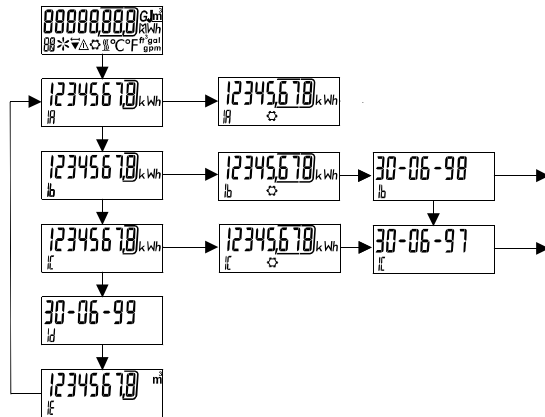

- 1A: Current heat meter reading – Current cold meter reading
- 1B: Latest heat target date value – Latest cold target date value – Latest target date
- 1C: Penultimate heat target date value – Penultimate cold target date value – Penultimate target date
- 1D: Date of next target date
- 1E: Current volume

Display loop 2:
Diagnostic loop

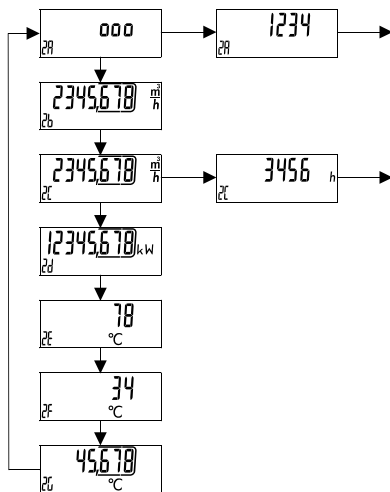

- 2A: Error code - operating time, here days since commissioning
- 2B: Current flow
- 2C: Maximal flow – hours with flow above the flow threshold
- 2D: Current capacity
- 2E: Flow temperature
- 2F: Backflow temperature
- 2G: Temperature difference

Nur für den internen Gebrauch — For internal use only — Uniquement pour utilisation interne

Nur für den internen Gebrauch — For internal use only — Uniquement pour utilisation interne

Display loop 3:
 Rating plate loop

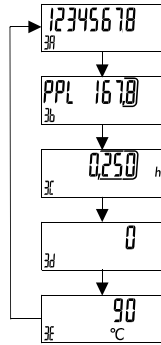

- 3A: Customer specific metering point number
- 3B: Pulse value
- 3C: Notice period for maximum rating of flow or capacity
- 3D: M-Bus address
- 3E: max. operating temperature of the heat meter

Display loop 4:
 Statistic loop

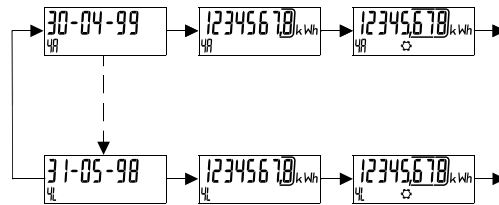

- 4A: Month end date (latest month) – Monthly heat energy – Monthly cold energy
- 4B-4L: Same as for the previous 11 months

Display loop 5:
 Rate loop

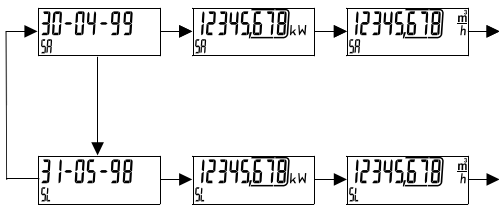

- 5A: Month's end date (last month) – max. capacity of the month – max. flow of the month
- 5B-5L: same for the previous 11 months

Error status

Display	Meaning
	No error
	10-year time period exceeded
	<ul style="list-style-type: none"> C: Calculator error t: Temperature sensor error F: Flow sensor error

1.4 Technical data

Place of installation (see type plate)

	Flow	Return
Heat meters	warmer string	Colder string
Combined heat/cold meters	warmer string	Colder string
Cold meters	Colder string	warmer string

Nominal flow q_p 0,6 / 1,5 / 2,5 (acc. rating plate)

Ambient conditions to EN 1434

- Mechanical: M2
- Electromagnetic: E1

Approved fluid Water

q_p / q_i

- asymmetric: 25
- symmetric: 50

Pressure loss at q_p in combination with EAS Rp 3/4

- q_p 0.6: $\Delta p = 0.16$ bar
- q_p 1.5: $\Delta p = 0.22$ bar
- q_p 2.5: $\Delta p = 0.24$ bar

Nominal pressure PN 16

Flow sensor temperature range limits (Θ)

	Θ_{min}	Θ_{max}
Heat meter	15 °C	90 °C
Combined heat/cold meter	5 °C	90 °C
Cold meter	5°	25 °C

Nur für den internen Gebrauch — For internal use only — Uniquement pour utilisation interne

Temperature measurement range limits (Θ) / Temperature difference limits ($\Delta\Theta$)

	Θ_{\min}	Θ_{\max}	$\Delta\Theta_{\min}$	$\Delta\Theta_{\max}$
Heat meter (flow)	5 °C	90 °C	3 K	85 K
Heat meter (return)	5 °C	150 °C	3 K	100 K
Combined heat/cold meter (flow)	5 °C	90 °C	3 K	85 K
Combined heat/cold meter (return)	1 °C	150 °C	3 K	100 K
Cold meters	1 °C	25 °C	3 K	20 K

Combined heat / cold meter changeover criteria

- $\Delta\Theta_{\text{limit}} = 0.19 \text{ K}$
- $\Theta_{\text{in_change}} = 20 \text{ °C}$

Cycle starting conditions

- Standard meters: $\Delta\Theta > 0 \text{ K}$
- Combined heat/cold meters:
 - Heat measurement: $\Delta\Theta > 0 \text{ K}$ and flow temperature $> 20 \text{ °C}$
 - Cold measurement: $\Delta\Theta < 0 \text{ K}$ and flow temperature $< 20 \text{ °C}$

Interfaces

- optical interface acc. EN 61107 (log acc. EN 60870-5)
- M-Bus interface (optional)

Transfer rate preferably 2400 baud (bit/s), also 300 baud possible.

Selection frequency

- at 300 baud (bit/s)
 - 1 time per day at 10 years battery life
 - 12 times per day at 5 years battery life
- at 2400 baud (bit/s)
 - 1 time per day at 10 years battery life
 - 96 times per day at 5 years battery life

Weight 0,652 kg - 0,760 kg (depending on variant)

Storage Dry and frost-protected

Temperature sensors Typ Pt 500 acc. EN 60751

Length sensor cable

- 1.5 m / 1 m (standard)
- 3 m / 1 m (optional)

Protection class IP54 according to EN 60529

Power supply 3 V lithium battery

Life cycle 10 years + 1 year reserve + 1 year storage

Approved temperature sensor combinations

	Asymmetrical	Symmetrical	
Cold string sensor (blue marking)	sealed in the meter	Ball valve	immersion sleeve
Hot string sensor (red marking)	immersion sleeve / ball valve	Ball valve	immersion sleeve

1.6 Main and connection dimensions

Main dimensions

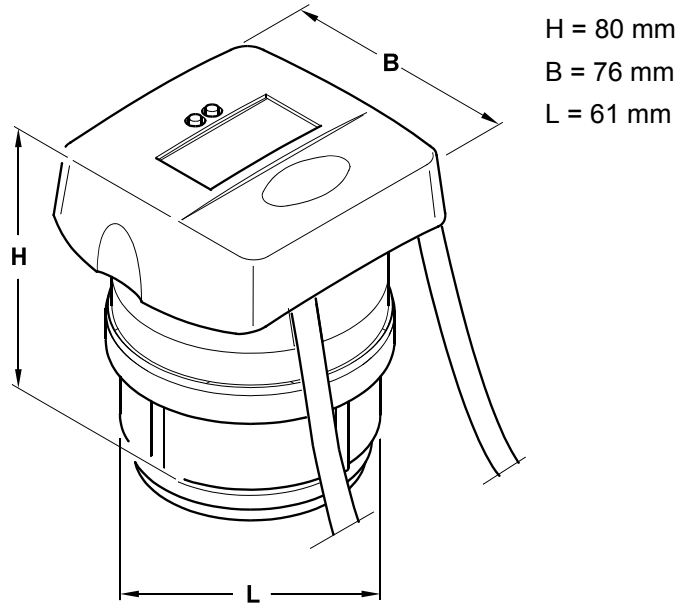

Lenght sensor cable

- Flow: 1,5 m (optional 3 m)
- Backflow: 1 m

Lenght M-Bus cable 1 m

i **2** **Item numbers**

Heat Meters

qp 0,6

59006	sonsonic II 0.6 1.5m 2se ext 15s. Measint
59009	sonsonic II 0.6/1.5m
59032	sonsonic II mbus 0.6/1.5m MID
59035	sonsonic II mbus 0.6/3.0m MID
59038	sonsonic II mbus 0.6/3.0m flow MID
59041	sonsonic II mbus 0.6/1.5m 2se.ext MID
59050	Sonsonic II mbus 0.6/3m 2sensors ext.MID
59120	sonsonic II 0.6/1.5m MID
59123	sonsonic II 0.6/3.0m MID
59147	sonsonic II 0.6/3.0m flow MID
59152	sonsonic II 0.6/1.5m 2se.ext MID
59158	sonsonic II 0.6/3.0m 2se.ext MID
59240	sonsonic II 0.6/3.0m mbus glycol
59302	sonsonic II 0.6/1.5m GJ MID
59305	sonsonic II 0.6/3.0m GJ MID
59311	sonsonic II 0.6/1.5m flow / GJ MID
59314	sonsonic II mbus 0.6/1.5m GJ MID
59317	sonsonic II mbus 0.6/1.5m flow/GJ MID
59324	sonsonic II mbus 0.6/3m 2se.ext flow MID
59326	sonsonic II 0.6/3.0m 2se.ext flow MID

qp 1,5

59007	sonsonic II 1.5/1.5m, 2se ext., 15s Measint
59010	sonsonic II 1.5/1.5m,15s Maesint. MID
59033	sonsonic II mbus 1.5/1.5m MID
59036	sonsonic II mbus 1.5/3.0m MID
59039	sonsonic II mbus 1.5/3.0m flow MID
59042	sonsonic II mbus 1.5/1.5m 2se.ext MID
59051	sonsonic II mbus 1.5/3m 2sensors ext.MID
59121	sonsonic II 1.5/1.5m MID
59124	sonsonic II 1.5/3.0m MID
59148	sonsonic II 1.5/3.0m flow MID
59154	sonsonic II 1.5/1.5m 2se.ext MID
59160	sonsonic II 1.5/3.0m 2se.ext MID
59241	sonsonic II 1.5/3.0m mbus glycol
59303	sonsonic II 1.5/1.5m GJ MID
59312	sonsonic II 1.5/1.5m flow / GJ MID
59315	sonsonic II mbus 1.5/1.5m GJ MID
59318	sonsonic II mbus 1.5/1.5m flow/GJ MID
59320	sonsonic II 1.5/3.0m 2se.ext flow MID
59322	sonsonic II mbus 1.5/3m 2se.ext flow MID

qp 2,5

59008	sonsonic II 2.5/1.5m,2se.ext.,15s Maesint
59011	sonsonic II 2.5/1.5m,15s Measint. MID
59034	sonsonic II mbus 2.5/1.5m MID
59037	sonsonic II mbus 2.5/3.0m MID
59040	sonsonic II mbus 2.5/3.0m flow MID
59043	sonsonic II mbus 2.5/1.5m 2se.ext MID
59052	sonsonic II mbus 2.5/3m 2sensors ext.MID
59122	sonsonic II 2.5/1.5m MID
59125	sonsonic II 2.5/3.0m MID
59149	sonsonic II 2.5/3.0m flow MID
59156	sonsonic II 2.5/1.5m 2se.ext MID

Nur für den internen Gebrauch — For internal use only — Uniquement pour utilisation interne

59161	sononic II 2.5/3.0m 2se.ext MID
59246	sononic II 2.5/3.0m mbus glycol
59304	sononic II 2.5/1.5m GJ MID
59313	sononic II 2.5/1.5m flow / GJ MID
59316	sononic II mbus 2.5/1.5m GJ MID
59319	sononic II mbus 2.5/1.5m flow/GJ MID
59321	sononic II 2.5/3.0m 2se.ext flow MID
59323	sononic II mbus 2.5/3m 2se.ext flow MID

Kältezähler

qp 0,6

19208	sononic II 0,6/3m 2 Fü.außen cooling
19211	sononic II 0,6/3m 2 Fü.auß.mbus cooling
19234	sononic II 0,6/3m mbus cooling

qp 1,5

19209	sononic II 1,5/3m 2 Fü.außen cooling
19212	sononic II 1,5/3m 2 Fü.auß.mbus cooling
19235	sononic II 1,5/3m mbus cooling
19238	sononic II 1,5/3m mbus cooling VL

qp 2,5

19210	sononic II 2,5/3m 2 Fü.außen cooling
19213	sononic II 2,5/3m 2 Fü.auß.mbus cooling
19236	sononic II 2,5/3m mbus cooling

Kombinierte Wärme-/Kältezähler

qp 0,6

59044	sononic II mbus 0,6/1,5m hybrid MID
59153	sononic II 0,6/1,5m hybrid MID
59180	sononic II 0,6/3m 2Fü.außen hybrid
59183	sononic II mbus 0,6/3m 2Fü.auß hybrid











qp 1,5

59045	sononic II mbus 1,5/1,5m hybrid MID
59155	sononic II 1,5/1,5m hybrid MID
59181	sononic II 1,5/3m 2Fü.außen hybrid
59184	sononic II mbus 1,5/3m 2Fü.auß hybrid
59325	sononic II mbus 1,5/1,5m hybrid GJ MID
59328	sononic II 1,5/1,5m hybrid GJ MID

qp 2,5



59046	sononic II mbus 2,5/1,5m hybrid MID
59157	sononic II 2,5/1,5m hybrid MID
59182	sononic II 2,5/3m 2Fü.außen hybrid
59185	sononic II mbus 2,5/3m 2Fü. auß hybrid
59329	sononic II 2,5/1,5m hybrid GJ MID

Single-pipe connectors (SPC)



14000	SPC 1/2" internal thread COMPL. Construction length 94mm brass	
14008	SPC 15 MM compl. Press system RB5	
14009	SPC 18 MM compl. Press system RB5	
14010	SPC 22 MM compl. Press system RB5	
14011	SPC 1/2" internal thread compl. Construction length 94mm RB5	
14012	SPC 3/4" internal thread compl. Construction length 100mm RB5	
14100	SPC 3/4" internal thread compl. Construction length 100mm brass	
14103	SPC 3/4" external thread 110mm RFV brass	
14107	SPC 1" external thread 110mm for temp. sensor brass	
14108	SPC 1" external thread 130mm for temp. sensor brass	
14200	SPC 15 MM COMPL. Solder connection brass	

Nur für den internen Gebrauch — For internal use only — Uniquement pour utilisation interne



Nur für den internen Gebrauch — For internal use only — Uniquement pour utilisation interne

14300	SPC 18 MM COMPL. Solder connection brass	
14400	SPC 22 MM COMPL. Solder connection brass	
14402	SPC 28 MM COMPL. Solder connection RB5	
14403	SPC 1" external thread 105mm RFV brass	
14404	SPC 1" external thread COMPL. CONSTRUCTION LENGTH 130 MM RB5	
14408	SPC 1" external thread compl. Construction length 190 MM RB5	
14414	SPC 1" external thread COMPL. CONSTRUCTION LENGTH 130 MM brass	
14450	Ball valve SPC 3/4" for built-in T-sensor	
14451	Ball valve SPC 1" for built-in T-sensor	
14949	SPC UNIVERSAL 3/4" F. WMI	
14950	SPC UNIVERSAL 1" F. WMI	

Ball valves

18527	sononic Zub ball valve 3/4" T-sens. Handle	
18528	sononic Zub ball valve 1" T-sens. Handle	
18529	sononic Zub ball valve 1/2" T-sens. Handle	

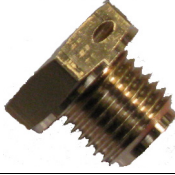
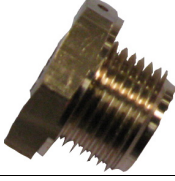
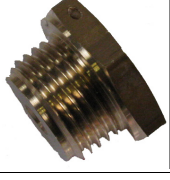
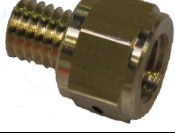
Adapter



18378	Adapter immersion sleeves Allmess M10x1 x G1/4	
18432	Adapter for direct installation temperature sensor G1/4"	
18433	Adapter for direct installation temperature sensor G3/8"	
18434	Adapter for direct installation temperature sensor G1/2"	
18435	Adapter for direct installation temperature sensor M10x1"	
50159	Adapter immersion sleeves 1/2" x 1/4" brass	

Nur für den internen Gebrauch — For internal use only — Uniquement pour utilisation interne







Nur für den internen Gebrauch — For internal use only — Uniquement pour utilisation interne

50162	Adapter immersion sleeves 3/4" x 1/4" nickel-plated	
-------	---	---



Seals

15001	Seal wire	
15006	Seal wire, coil a 100 m	
15022	Selflock seal lge series IST/Logo	

Immersion sleeves

18380	Immersion sleevesG 1/4 B, 5/50 mm/compl.	
18381	Immersion sleevesG 1/4 B, 5/80 mm/compl.	
18382	Immersion sleevesG 1/4 B, 5/150mm/compl.	
18391	IMMERSION SLEEVES SET G 1/4B.5/ 50mm/ welded m.	
18392	IMMERSION SLEEVES SET G 1/4B.5/ 80mm/ welded m.	
18393	IMMERSION SLEEVES SET G 1/4B.5/ 150mm/welded m.	

Werkzeug

80008	WMI-HAKENSCHLÜSSEL GR.68/75 DIN1810 A	
80518	Hakenschlüssel	

- The unit may only be mounted by authorized expert personell!
- Use this device in an environment that fulfills the indicated operating conditions.
- Do not install in a dry system, as otherwise functional and leak testing will not be possible.
- Protect the meter from knocks and vibrations.
- The requirements on circulating water of the German Heat and Power Association (AGFW) must be followed.
- Use the included sealing material to seal the device. The use of hemp and sealing compound is prohibited.
- Do not weld pipes if a meter is already installed.
- Install the device either vertically or horizontally. No other installed positions are allowed. If installed in a horizontal position, the indicating device must not face downwards (turn through 90° max.).
- Rinse the pipes thoroughly before installing the meter. If there is a high risk of contamination, install a filter upstream of the device. Note and follow Directive EN 1434-6.
- If the sensors are installed asymmetrically, the nominal operating conditions as per the rating plate will be limited.
- The hydraulics may only be installed in SPC to EN 14154 (2011) Type "IST" (or equivalent SPC). This can be recognised by one of the following forms of lettering:
 - "IST"
 - "ista"
 - "viterra"
- RaabKarcher logo 
- The SPCs marked with the "ista", "viterra" or RaabKarcher logo are to be labelled with the enclosed "IST" seal. Use of adapters is prohibited.
- The temperature sensors must only be installed in the above-mentioned immersion sleeves. These immersion sleeves are labelled with the "ista", "sonsonic", "viterra" or the Raab-Karcher logo.
- After mixing, a supply length of 10DN is required to ensure a sufficient temperature mix.
- The flow sensor and temperature sensor of the heat meter must be located in the same partial circuit of the system (same circuit rule).
- Upstream and downstream of the sensonic II, shut-off valves must be installed for use during device replacement.
- When installing, maintain a minimum distance of 10 cm between the meter cables and 230 V supply cables and 50 cm between the meter and electromagnetic interference sources (e.g. switches, controllers, power packs, motors) and their wiring.
- Always lay all the device's cables at a minimum distance of 30 cm from power or high frequency cables.
- Do not coil, extend or shorten the sensor cables.
- The installation site must always ensure complete filling of the measuring insert with water.
- You may only transport the sensonic II in its original packaging.
- Cavitation caused by overpressure must be avoided within the whole measurement range, i.e. at least 1 bar at q_p and approx. 3 bar for overload q_s (applies to approx. 80 °C).
- Only remove user seals if you are authorised to do so. The seals must be replaced after the work is completed.
- To properly adhere to calibration error limits, the current state-of-the-art as well as notes and facts in this document must be observed.
- If using as a cold meter or combined heat/cold meter we recommend disconnecting the ALU from the flow sensor and mounting it on the wall so that condensation cannot flow along the cable and penetrate the ALU.
- When commissioning a heat meter, we recommend writing a commissioning protocol as described in PTB K6.
- If used as a cold meter or combined heat / cold meter, only symmetrical, direct installation (e.g. ball valve) of the temperature sensors is allowed.
- In new systems in Germany, temperature sensors must be installed in pipes (DN < 25) directly (e.g. ball valve).



4 Installation

4.1 Mounting meter

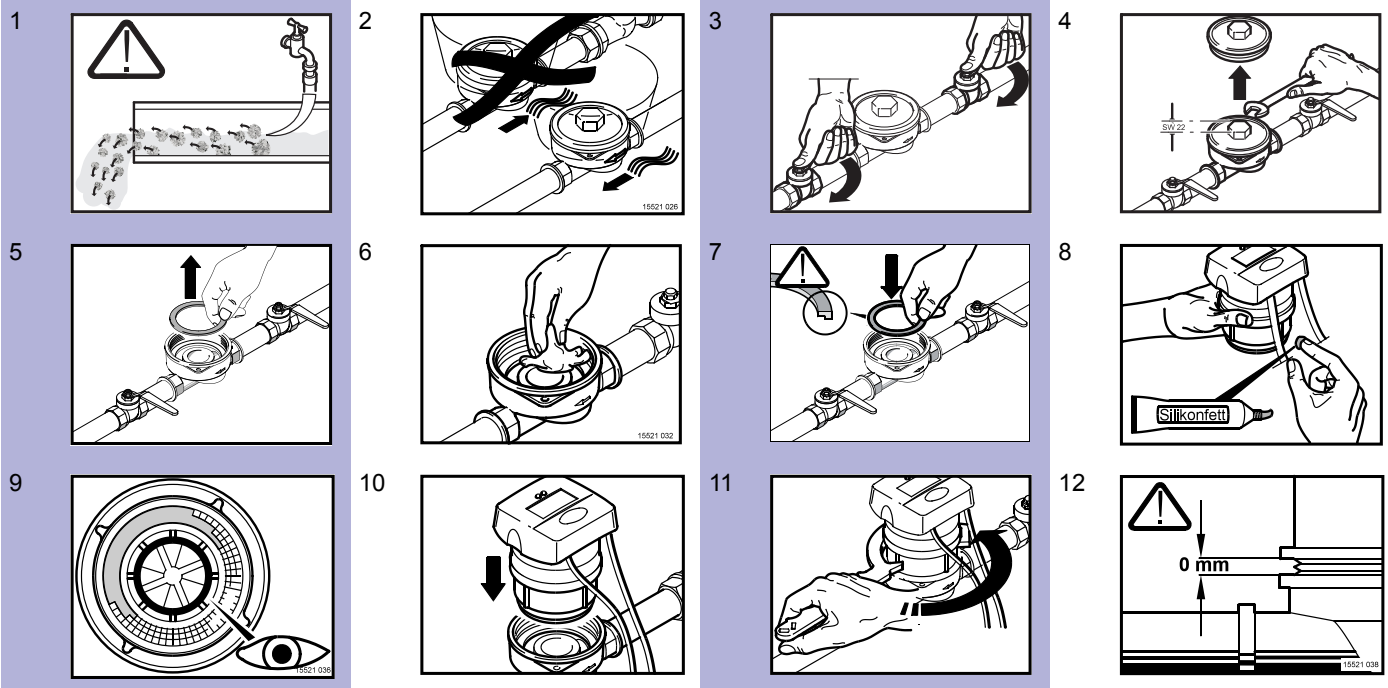

1. Flush pipeline according to DIN/EN. Observe the country specific regulations!
2. Observe the directional flow comparing it with the arrow on the SPC.
3. Close the shut-off devices.
4. Unscrew the overflow cap (SW 22).
5. Remove profile seal.
6. Clean sealing surfaces.
7. Insert the profile seal with the flat part on top.

NOTICE

- ▶ Only insert one profile seal!
8. Grease the external thread of the meter with food-grade silicone grease.
 9. Make sure that the meter's o-ring lies in the groove.
 10. Screw in the meter.
 11. Tighten meter with wrench.
 12. Screw in meter up to the metallic stop and rotate it to the proper reading position.

4.2 Installation of the temperature sensor in the immersion sleeve $\frac{1}{4}$ " (\varnothing 5 mm)

i NOTICE

- ▶ Note the above-mentioned conditions for the sensor installation.

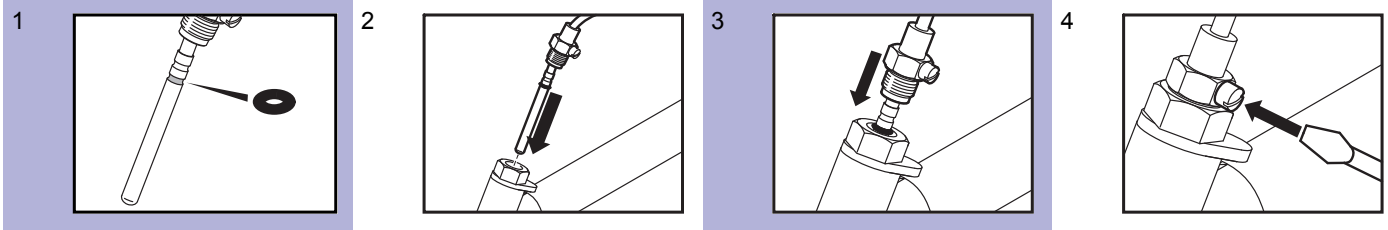

1. Insert O-ring (1) into the first groove (as seen from the sensor tip).
2. Insert temperature sensor in immersion sleeve - surface low

3. Tighten seal screw.
4. Tighten the locking screw.

Nur für den internen Gebrauch — For internal use only — Uniquement pour utilisation interne

4.3 Install temperature sensor in the ball valve and single-pipe connector (SPC) with slot for temperature sensor

NOTICE

▶ Note the above-mentioned conditions for the sensor installation.

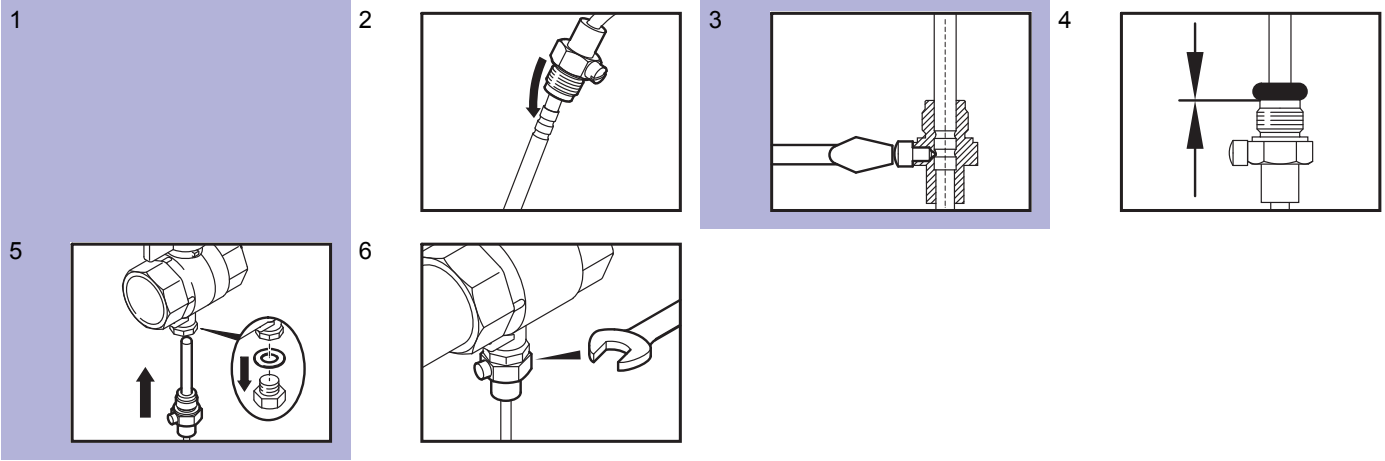

1. Remove blind screw coupling and seal from ball valve without residue.
2. Slide seal screw to stop unit over the temperature sensor.
3. Tighten locking screw in second groove (as seen from the sensor tip).
4. Slide O-ring until the stop unit of the seal screw
5. Install the temperature sensor into the ball valve.
6. Tighten seal screw.

4.4 Final steps

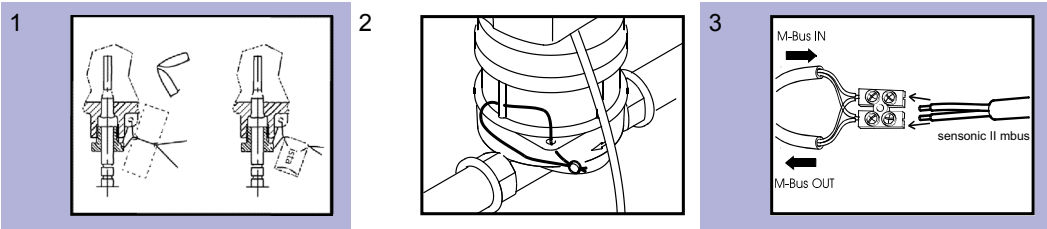

1. Seal temperature sensor.
2. Seal meter.
3. If necessary, connect with the M bus.

NOTICE

▶ If the sensor is installed asymmetrically it is sealed in the meter and may not be removed. Equally, if installed symmetrically the sensor installation location in the meter must not be used.



5 Commissioning

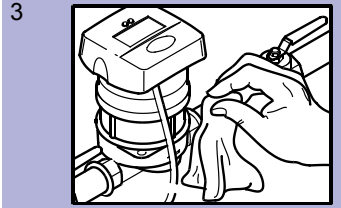
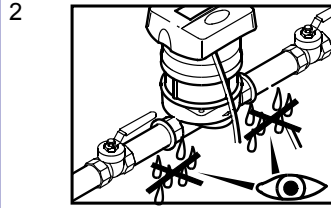
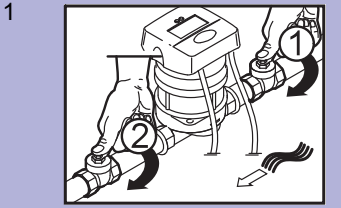

1. Slowly open shut-off valves, the supply line first.
2. Check for function and leakage.

3. Clean the outside of the sensonic II with a damp cloth. Do not use cleaning products.



6 Exchange

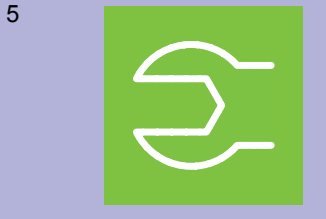
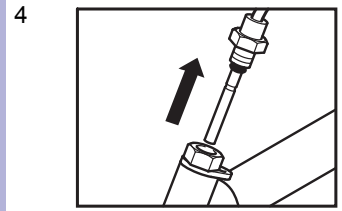
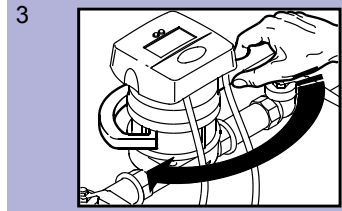
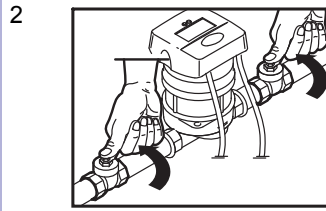
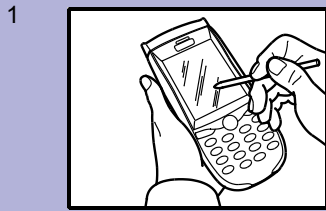

1. Note meter reading of meter.
2. Close the shut-off devices.
3. Use wrench to unscrew meter.

4. Remove temperature sensor.
5. To continue, see "Installation" as of step 5



7 Disposal

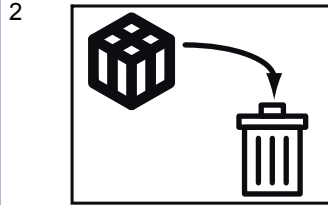
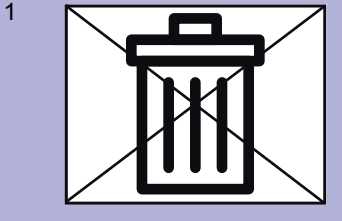

1. Do not dispose of the old device in the household waste.
2. Send obsolete devices to the main warehouse via outlet.

They will ensure proper disposal.